

Beta

C45PRO

2.0



THE MODULAR WORKSHOP EQUIPMENT

WITH 61,5_{cm} DEEP WORKTOP

Promotion valid until 28.02.2026

Beta

C45PRO

2.0

TAILOR YOUR WORK ENVIRONMENT TO SUIT YOUR NEEDS.

Make your workshop or garage look different.

Choose from the preassembled solutions or create your workstation from scratch.

The modular workshop equipment, **C45PRO 2.0**, allows you to create your own work environment according to both the amount of space you have available and your usage requirements.



Adjustable feet



Aluminium handle



Tidy and practical

This **simple, flexible** range based on predetermined combinations, can be **expanded** or **changed** in time.

Alternatively, you can **fully customize your workstation**, starting with the worktops - available in **stainless steel** coated MDF or **multi-ply wood** - and supplementing them with the numerous parts and accessories you can choose from.

We are proud to introduce the **2.0 version** of our successful range, **C45PRO**.

61,5cm

Based on the **new 61,5-cm-deep worktop**, this range stands out as even more convenient and professional, with a view to increasingly meeting the most demanding professionals' requirements.



THE MODULAR WORKSHOP EQUIPMENT, C45PRO 2.0

allows you to create your own work environment according to both the amount of space you have available and your usage requirements.

C45PRO 2.0 D

Combination comprising:

2000 mm
645 mm
3718+3038 mm



- 1 fixed module with 7 drawers (C45PRO 2.0 M7)
- 1 mobile roller cab with 7 drawers (C45PRO 2.0 C7)
- 1 fixed service module (C45PRO 2.0 MS)
- 1 fixed module with 5 drawers (C45PRO 2.0 M5)
- 1 fixed two-door module (C45PRO 2.0 MA)
- 5 perforated tool panels (C45PRO 2.0 PF)
- 5 wall-mounted cabinets (C45PRO 2.0 PM)
- 7 wall brackets, wide type (C45PRO 2.0 SL)
- 2 wall brackets, narrow type (C45PRO 2.0 SS)
- 2 single-door cabinets (C45PRO 2.0 AS1)



C45PRO 2.0 DX

045002031

- 1 stainless steel coated MDF worktop, dimensions 2,040x615 mm (C45PRO 2.0 PXE/3-2.0MT)
- 1 stainless steel coated MDF worktop, dimensions 1,360x615 mm (C45PRO 2.0 PXE/2-1.3MT)
- 1 self-supporting complete corner with stainless steel coated MDF worktop (C45PRO 2.0 CORNER/X)



640 kg

C45PRO 2.0 DW

045002032

- 1 multi-ply wood worktop, dimensions 2,040x615 mm (C45PRO 2.0 PWE/3-2.0MT)
- 1 multi-ply wood worktop, dimensions 1,360x615 mm (C45PRO 2.0 PWE/2-1.3MT)
- 1 self-supporting complete corner with multi-ply wood worktop (C45PRO 2.0 CORNER/W)



606 kg

C45PRO 2.0 F

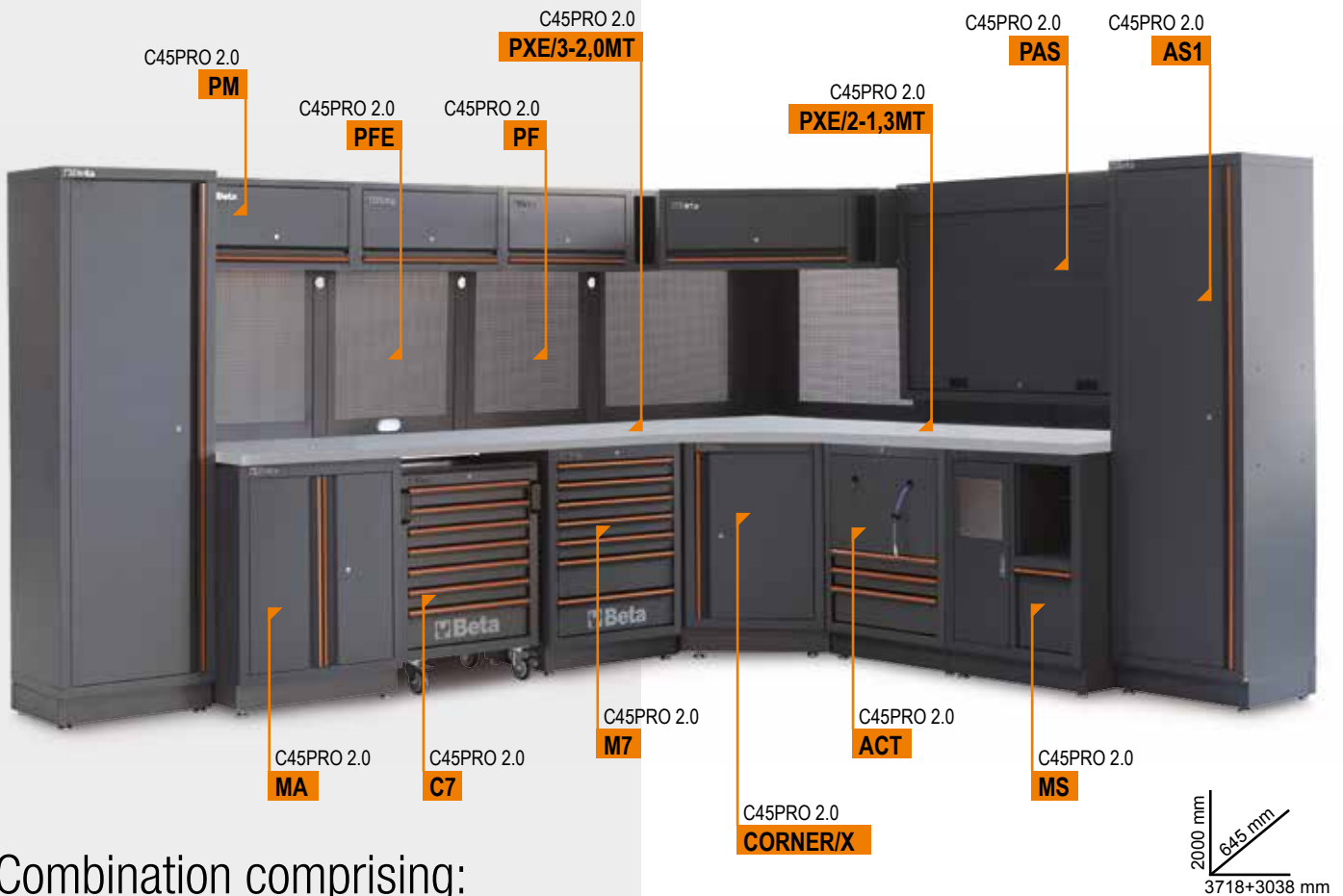

Combination comprising:

- 1 fixed two-door module (C45PRO 2.0 MA)
- 1 mobile roller cab with 7 drawers (C45PRO 2.0 C7)
- 1 fixed module with 7 drawers (C45PRO 2.0 M7)
- 1 fixed module **with 2 built-in reels** (C45PRO 2.0 ACT)
- 1 fixed service module (C45PRO 2.0 MS)
- 2 perforated tool panels (C45PRO 2.0 PF)
- 1 perforated tool panel, can be fitted with a power socket (not included) (C45PRO 2.0 PFE)
- 3 wall-mounted cabinets (C45PRO 2.0 PM)
- 1 tool wall system with aluminium shutter (C45PRO 2.0 PAS)
- 6 wall brackets, wide type (C45PRO 2.0 SL)
- 4 wall brackets, narrow type (C45PRO 2.0 SS)
- 2 single-door cabinets (C45PRO 2.0 AS1)

INCLUDED



1900S 8x10



1844 15-H05

C45PRO 2.0 FX

045002035

- 1 stainless steel coated MDF worktop, dimensions 2,040x**615** mm (C45PRO 2.0 PXE/3-2,0MT)
- 1 stainless steel coated MDF worktop, dimensions 1,360x**615** mm (C45PRO 2.0 PXE/2-1,3MT)
- 1 self-supporting complete corner with stainless steel coated MDF worktop (C45PRO 2.0 CORNER/X)

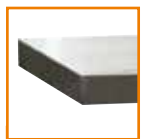

658 kg

C45PRO 2.0 FW

045002045

- 1 multi-ply wood worktop, dimensions 2,040x**615** mm (C45PRO 2.0 PWE/3-2,0MT)
- 1 multi-ply wood worktop, dimensions 1,360x**615** mm (C45PRO 2.0 PWE/2-1,3MT)
- 1 self-supporting complete corner with multi-ply wood worktop (C45PRO 2.0 CORNER/W)



625 kg

C45PRO 2.0 G



Combination comprising:

- 1 fixed module **with 2 built-in reels** (C45PRO 2.0 ACT)
- 1 mobile roller cab with 7 drawers (C45PRO 2.0 C7)
- 1 fixed module with 7 drawers (C45PRO 2.0 M7)
- 1 fixed two-door module (C45PRO 2.0 MA)
- 1 perforated tool panel (C45PRO 2.0 PF)
- 1 perforated tool panel, can be fitted with a power socket (not included) (C45PRO 2.0 PFE)
- 2 wall-mounted cabinets (C45PRO 2.0 PM)
- 1 tool wall system with aluminium shutter (C45PRO 2.0 PAS)
- 5 wall brackets, wide type (C45PRO 2.0 SL)
- 4 wall brackets, narrow type (C45PRO 2.0 SS)
- 2 single-door cabinets (C45PRO 2.0 AS1)

INCLUDED



1900S 8x10

1844 15-H05

C45PRO 2.0 GX

045002036

- 1 stainless steel coated MDF worktop, dimensions 2,040x**615** mm (C45PRO 2.0 PXE/3-2.0MT)
- 1 stainless steel coated MDF worktop, dimensions 680x**615** mm (C45PRO 2.0 PXE/1-0.7MT)
- 1 self-supporting complete corner with stainless steel coated MDF worktop (C45PRO 2.0 CORNER/X)

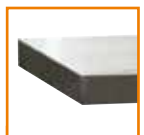

554 kg

C45PRO 2.0 GW

045002037

- 1 multi-ply wood worktop, dimensions 2,040x**615** mm (C45PRO 2.0 PWE/3-2.0MT)
- 1 multi-ply wood worktop, dimensions 680x**615** mm (C45PRO 2.0 PWE/1-0.7MT)
- 1 self-supporting complete corner with multi-ply wood worktop (C45PRO 2.0 CORNER/W)



551 kg

C45PRO 2.0

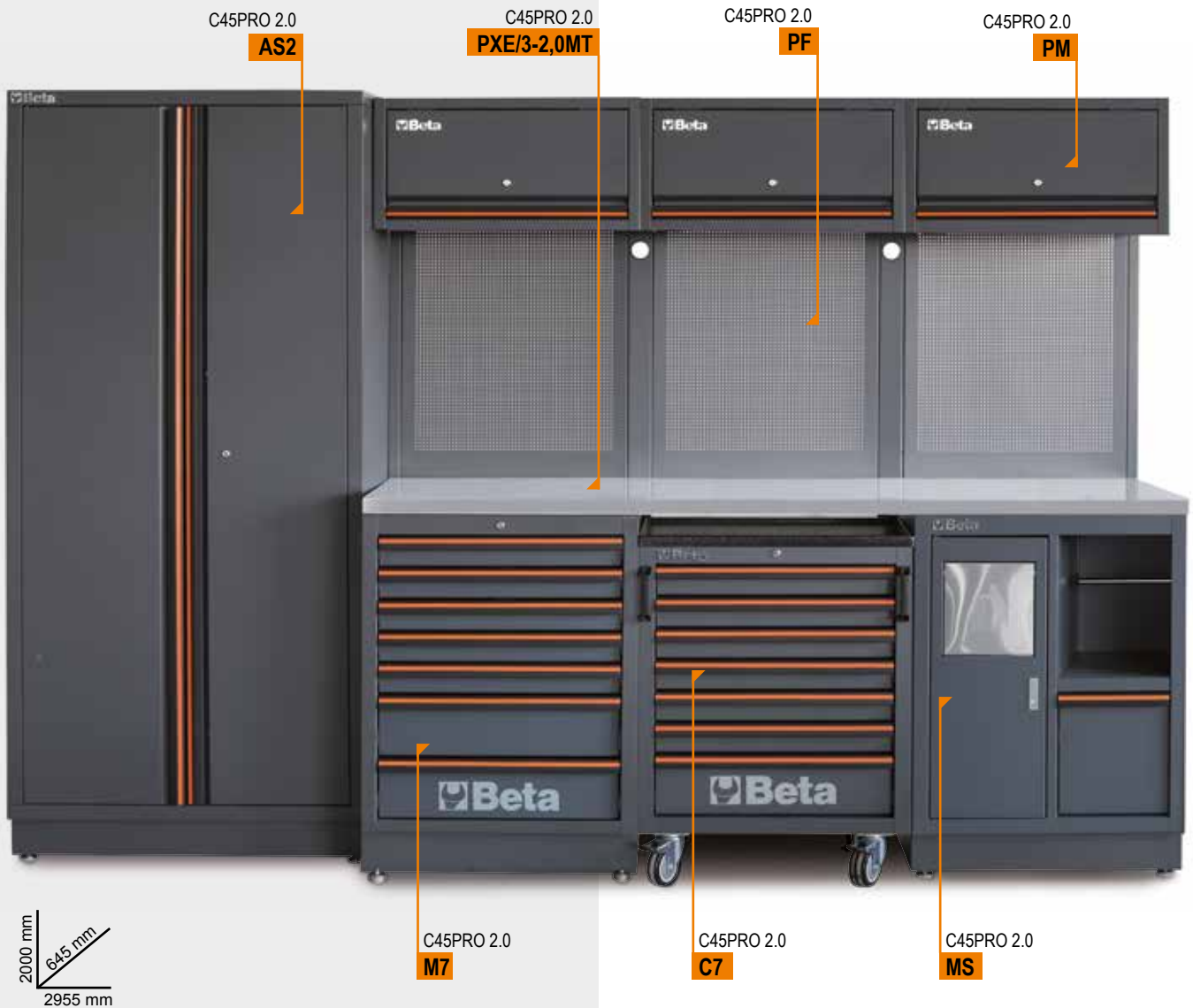

Combination comprising:

- Fixed module with 7 drawers (C45PRO 2.0 M7)
- Mobile roller cab with 7 drawers (C45PRO 2.0 C7)
- Fixed service module (C45PRO 2.0 MS)
- 3 perforated tool panels (C45PRO 2.0 PF)
- 3 wall-mounted cabinets (C45PRO 2.0 PM)
- 3 wall brackets, wide type (C45PRO 2.0 SL)
- 1 wall bracket, narrow type (C45PRO 2.0 SS)
- Two-door cabinet (C45PRO 2.0 AS2)

C45PRO 2.0 X

045002001

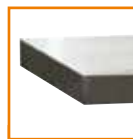

334 kg

- Stainless steel coated MDF worktop, dimensions 2,040x615 mm (C45PRO 2.0 PXE/3-2,0MT)

C45PRO 2.0 W

045002002



318 kg

- Multi-ply wood worktop, dimensions 2,040x615 mm (C45PRO 2.0 PWE/3-2,0MT)

C45PRO 2.0 H



Combination comprising:

- 1 fixed module **with 2 built-in reels** (C45PRO 2.0 ACT)
- 1 mobile roller cab with 7 drawers (C45PRO 2.0 C7)
- 1 fixed module with 4 drawers (C45PRO 2.0 M4)
- 3 wall-mounted cabinets (C45PRO 2.0 PM)
- 3 perforated tool panels (C45PRO 2.0 PF)
- 3 wall brackets, wide type (C45PRO 2.0 SL)
- 1 wall bracket, narrow type (C45PRO 2.0 SS)
- 1 two-door cabinet (C45PRO 2.0 AS2)

INCLUDED



1900S 8x10



1844 15-H05

C45PRO 2.0 HX

045002038

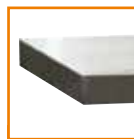

333 kg

- 1 stainless steel coated MDF worktop, dimensions 2,040x615 mm (C45PRO 2.0 PXE/3-2.0MT)

C45PRO 2.0 HW

045002039



318 kg

- 1 multi-ply wood worktop, dimensions 2,040x615 mm (C45PRO 2.0 PWE/3-2.0MT)

C45PRO 2.0 **A**

Combination comprising:

- Fixed service module (C45PRO 2.0 MS)
- Fixed module with 7 drawers (C45PRO 2.0 M7)
- Fixed two-door module (C45PRO 2.0 MA)
- 3 wall-mounted cabinets (C45PRO 2.0 PM)
- 3 perforated tool panels (C45PRO 2.0 PF)
- 2 wall brackets, wide type (C45PRO 2.0 SL)
- 2 wall brackets, narrow type (C45PRO 2.0 SS)

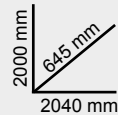

C45PRO 2.0 **AX**

045002003

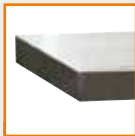

234,5 kg

- Stainless steel coated MDF worktop, dimensions 2,040x615 mm (C45PRO 2.0 PXE/3-2.0MT)

C45PRO 2.0 **AW**

045002004



219 kg

- Multi-ply wood worktop, dimensions 2,040x615 mm (C45PRO 2.0 PWE/3-2.0MT)

C45PRO 2.0 **B**

Combination comprising:

- Fixed module with 5 drawers (C45PRO 2.0 M5)
- Fixed two-door module (C45PRO 2.0 MA)
- 2 wall-mounted cabinets (C45PRO 2.0 PM)
- 2 perforated tool panels (C45PRO 2.0 PF)
- 2 wall brackets, wide type (C45PRO 2.0 SL)
- 1 wall bracket, narrow type (C45PRO 2.0 SS)
- Single-door cabinet (C45PRO 2.0 AS1)

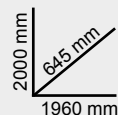

C45PRO 2.0 **BX**

045002021



206 kg

- Stainless steel coated MDF worktop, dimensions 1,360x615 mm (C45PRO 2.0 PXE/2-1.3MT)

C45PRO 2.0 **BW**

045002022



196 kg

- Multi-ply wood worktop, dimensions 1,360x615 mm (C45PRO 2.0 PWE/2-1.3MT)

C45PRO 2.0 C

Combination comprising:

- Fixed service module (C45PRO 2.0 MS)
- Fixed module with 7 drawers (C45PRO 2.0 M7)
- 2 wall-mounted cabinets (C45PRO 2.0 PM)
- 2 perforated tool panels (C45PRO 2.0 PF)
- 2 wall brackets, wide type (C45PRO 2.0 SL)
- 1 wall bracket, narrow type (C45PRO 2.0 SS)
- Single-door cabinet (C45PRO 2.0 AS1)

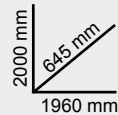

C45PRO 2.0 CX

045002023

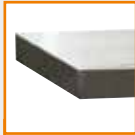

225 kg

- Stainless steel coated MDF worktop, dimensions 1,360x**615** mm (C45PRO 2.0 PXE/2-1.3MT)

C45PRO 2.0 CW

045002024



215 kg

- Multi-ply wood worktop, dimensions 1,360x**615** mm (C45PRO 2.0 PWE/2-1.3MT)

C45PRO 2.0 E

Combination comprising:

- 2 perforated tool panels (C45PRO 2.0 PF)
- 2 wall-mounted cabinets (C45PRO 2.0 PM)
- 2 wall brackets, wide type (C45PRO 2.0 SL)
- 1 wall bracket, narrow type (C45PRO 2.0 SS)
- 1 single-door cabinet (C45PRO 2.0 AS1)

Fixed module with 7 drawers

- 1 drawer 1,248x406 mm
- 6 drawers 782x406 mm
- 5 drawers 65 mm high
- 1 drawer 145 mm high
- 1 storage compartment with intermediate shelf and door

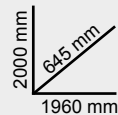

C45PRO 2.0 EX

045002033



203 kg

- Fixed module with 7 drawers and stainless steel coated MDF worktop, dimensions 1,360x**615** mm (C45PRO 2.0 M7A/X)

C45PRO 2.0 EW

045002034



193 kg

- Fixed module with 7 drawers and multi-ply wood worktop, dimensions 1,360x**615** mm (C45PRO 2.0 M7AW)

C45PRO 2.0 **BP-1,3**

Workbenches combination comprising:

- Fixed module with 7 drawers (C45PRO 2.0 M7)
- Fixed module with 5 drawers (C45PRO 2.0 M5)
- 2 perforated tool panels (C45PRO 2.0 PF)
- 1 wall bracket, wide type (C45PRO 2.0 SL)
- 2 wall brackets, narrow type (C45PRO 2.0 SS)



C45PRO 2.0 **BPX-1,3**

045002041

- Stainless steel coated MDF worktop, dimensions 1,360x**615** mm (C45PRO 2.0 PXE/2-1.3MT)

155 kg

C45PRO 2.0 **BPW-1,3**

045002051

- Multi-ply wood worktop, dimensions 1,360x**615** mm (C45PRO 2.0 PWE/2-1.3MT)

145 kg

C45PRO 2.0 **BP-2,0**

Workbenches combination comprising:

- Fixed module with 7 drawers (C45PRO 2.0 M7)
- Fixed module with 5 drawers (C45PRO 2.0 M5)
- 3 perforated tool panels (C45PRO 2.0 PF)
- 2 wall brackets, wide type (C45PRO 2.0 SL)
- 2 wall brackets, narrow type (C45PRO 2.0 SS)



C45PRO 2.0 **BPX-2,0**

045002042

- Stainless steel coated MDF worktop, dimensions 2,040x**615** mm (C45PRO 2.0 PXE/3-2.0MT)

181 kg

C45PRO 2.0 **BPW-2,0**

045002052

- Multi-ply wood worktop, dimensions 2,040x**615** mm (C45PRO 2.0 PWE/3-2.0MT)

165 kg

C45PRO 2.0 **BL**

Workbench

- Sheet metal framework
- With vertically adjustable feet
- Can accommodate a vice (1599P/150, to be ordered separately)

- **To be used only as an addition to a workshop equipment combination, not as a stand-alone element**

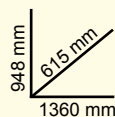

C45PRO 2.0 **BLX**

045002156

- Worktop (1,360x**615** mm) made from stainless steel coated MDF (C45PRO 2.0 PXE/2-1.3MT)

NEW

C45PRO 2.0 **BLW**

045002157

- Worktop (1,360x**615** mm) made from multi-ply wood (C45PRO 2.0 PWE/2-1.3MT)

NEW

C45PRO 2.0 **M7A**

Fixed module with 7 drawers

- 1 drawer (1,248x406 mm) with ball bearing slides
- 6 drawers (782x406 mm) with ball bearing slides:
 - 5 drawers 65 mm high
 - 1 drawer 145 mm high
- Drawer bases protected by foamed rubber mats
- Front centralized lock
- With vertically adjustable feet
- Can be fitted with thermoformed trays
- 1 storage compartment with intermediate shelf and door, interior dimensions 504x424x597 mm
- Can accommodate a vice (1599P/150, to be ordered separately)



C45PRO 2.0 **M7A/X**

045002161

- Worktop (1,360x615 mm) made from stainless steel coated MDF

81 kg

C45PRO 2.0 **M7A/W**

045002171

- Multi-ply wood worktop, 1,360x615 mm

80 kg

h	max
65 mm	25 kg
105 mm	40 kg
145 mm	30 kg

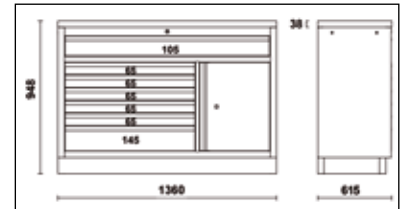

C45PRO 2.0 **MWS**

Work Station roller cab with 7 drawers and built-in waste bin

- 1 drawer (1248x406 mm) with ball bearing slides
- 6 drawers (782x406 mm) with ball bearing slides:
 - 5 drawers 65 mm high
 - 1 drawer 145 mm high
- drawer bases protected by foamed rubber mats
- can be fitted with thermoformed trays
- storage compartment with intermediate shelf and door, interior dimensions 504x424x597 mm
- built-in waste bin
- built-in paper roll compartment
- 4 heavy-duty castors, Ø 150 mm, 2 fixed and 2 steering with brakes
- front centralised lock
- can accommodate a vice (1599P/150, to be ordered separately)



C45PRO 2.0 **CPF**



Pair of perforated tool panels

C45PRO 2.0 **MWS/X**

045000181

- Worktop (1680 mm) made of stainless steel coated MDF

126 kg

C45PRO 2.0 **MWS/W**

045000191

- Multi-ply wood worktop (1680 mm)

122 kg

h	max
65 mm	25 kg
105 mm	40 kg
145 mm	30 kg

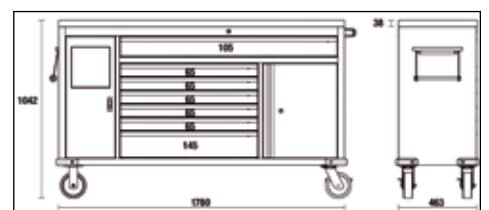

C45PRO 2.0 CORNER

Self-supporting complete corner

- Suspended corner cabinet with lock and 2 storage compartments
- 2 perforated tool panels (1,052x800 mm)
- Lower corner module with large storage compartment
- With vertically adjustable feet

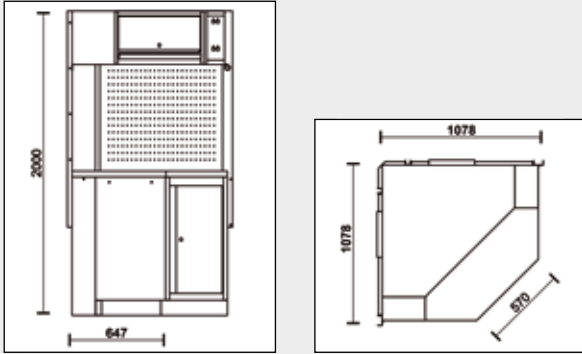

C45PRO 2.0 CORNER/X

045002401

- Stainless steel coated MDF corner worktop (1,018x1,018 mm)

127 kg

C45PRO 2.0 CORNER/W

045002411

- Multi-ply wood corner worktop (1,018x1,018 mm)

119 kg

C45PRO 2.0 CAI

Lower corner module

- Fixed corner module with large storage compartment
- With vertically adjustable feet

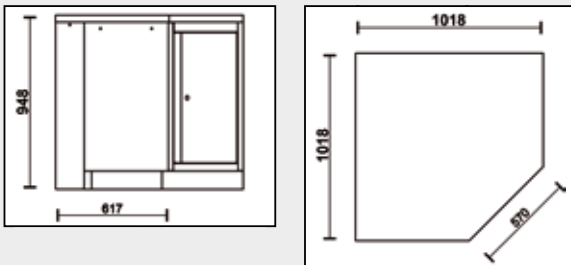

C45PRO 2.0 CAI/X

045002412

- Stainless steel coated MDF corner worktop (1,018x1,018 mm)

77 kg

C45PRO 2.0 CAI/W

045002402

- Multi-ply wood corner worktop (1,018x1,018 mm)

69 kg

C45PRO 2.0 **PXE**

Worktop made from stainless steel coated MDF

- thickness: 38 mm
- can accommodate a vice (1599P/150, to be ordered separately)
- complete with 6 spacers and 2 exterior side pads



C45PRO 2.0 **PXE/1-0,7MT**

045002131

 680x**615**x38 mm

14 kg

C45PRO 2.0 **PXE/2-1,3MT**

045002133

 1360x**615**x38 mm

27 kg

C45PRO 2.0 **PXE/3-2,0MT**

045002140

 2040x**615**x38 mm

41,5 kg

C45PRO 2.0 **PWE**

Worktop made from multi-ply wood

- thickness: 38 mm
- can accommodate a vice (1599P/150, to be ordered separately)
- complete with 6 spacers and 2 exterior side pads



C45PRO 2.0 **PWE/1-0,7MT**

045002141

 680x**615**x38 mm

8 kg

C45PRO 2.0 **PWE/2-1,3MT**

045002143

 1360x**615**x38 mm

17 kg

C45PRO 2.0 **PWE/3-2,0MT**

045002150

 2040x**615**x38 mm

26 kg

1599P/150

015990050

Parallel bench vices

- Hardened jaws
- Anvil with large lacquered surface
- Square steel base

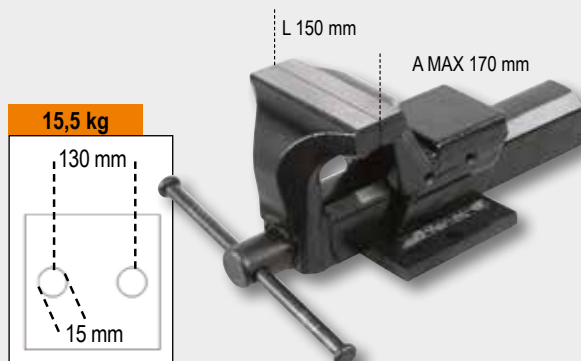

C45PRO 2.0 **T3**

045000250

3-tier tool trolley

- 4 swivel castors, Ø 100 mm (one with brake)
- Static load capacity: 200 kg (distributed over 3 shelves)

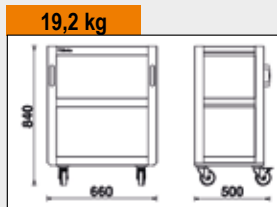

C45PRO 2.0 C5

045000226

Mobile roller cab with 5 drawers

- ABS worktop with anti-fall edges
- 5 drawers (532x406 mm) with ball bearing slides
- 4 swivel castors, Ø 100 mm (2 with brakes)
- Drawer bases protected by foamed rubber mats
- Front centralized lock
- Can be fitted with thermoformed trays
- Handles built into frame for improved ease of handling

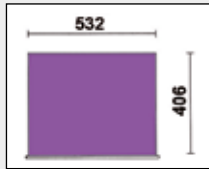

h	max
65 mm	25 kg
145 mm	30 kg

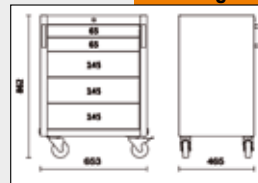

C45PRO 2.0 C7

045000228

Mobile roller cab with 7 drawers

- ABS worktop with anti-fall edges
- 7 drawers (532x406 mm) with ball bearing slides
- 4 swivel castors, Ø 100 mm (2 with brakes)
- Drawer bases protected by foamed rubber mats
- Front centralized lock
- Can be fitted with thermoformed trays
- Handles built into frame for improved ease of handling

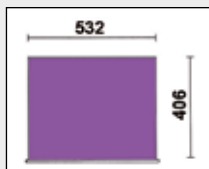

h	max
65 mm	25 kg
145 mm	30 kg

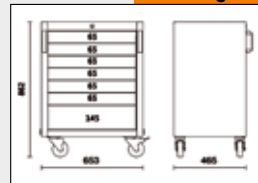

C45PRO 2.0 MA

045000232

Fixed two-door module

- With lock
- Vertically adjustable interior shelf
- Interior dimensions: 670x420 mm
- With vertically adjustable feet



C45PRO 2.0 MS

045000239

Fixed service module

- Built-in waste bin
- Paper roll compartment
- With vertically adjustable feet



C45PRO 2.0 MAL

045000229

Fixed module, 1360 mm long, with 2 sheet metal doors

- With lock
- Vertically adjustable interior shelf
- Interior dimensions: 1,355x420 mm
- With vertically adjustable feet



44,8 kg

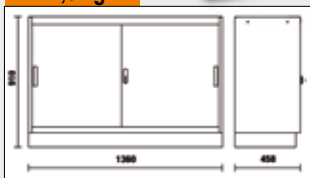

C45PRO 2.0 MAT

045000230

Fixed module, 1360 mm long, with 2 clear polycarbonate doors

- With lock
- Vertically adjustable interior shelf
- Interior dimensions: 1,355x420 mm
- With vertically adjustable feet



44,1 kg

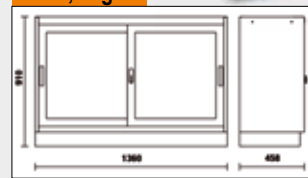

C45PRO 2.0 M3A

045000231

Fixed module with 3 drawers and 2 doors

- 3 drawers (566x406 mm) with ball bearing slides
- Drawer bases protected by foamed rubber mats
- Can be fitted with thermoformed trays
- Front centralized lock
- Storage compartment with double door and lock (interior dimensions 670x440 mm), complete with intermediate shelf
- With vertically adjustable feet

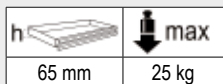
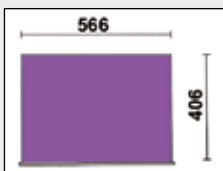

44 kg

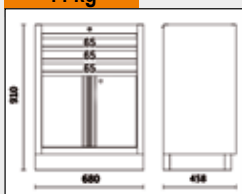

C45PRO 2.0 MRE

045000242

Fixed module for charging power tools

NEW

- Pull-out side compartment with ball bearing slides, for storing power tools
- Fixed side compartment with door and lock for storing chargers and batteries, equipped with: vertically adjustable shelf; rubber-protected cable bushings; ventilation slots;
- 1 drawer (256x400x190 mm), with ball bearing slides
- Front centralized lock
- Vertically adjustable feet



57 kg

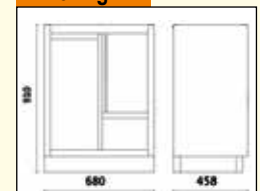

C45PRO 2.0 RD

Fixed sorted waste collection module

- Sturdy sheet metal frame complete with 4 containers with up-and-over door for sorting waste
- Each container is fitted with:
 - one removable plastic bin; capacity: 25 l
 - 4 swivel castors, Ø 60 mm
- Supplied with kit of 4 coloured adhesive tapes
- With vertically adjustable feet

C45PRO 2.0 RD/X 045002241

- Stainless steel coated MDF worktop (1360x615 mm)

C45PRO 2.0 RD/W 045002240

- Multi-ply wood worktop (1,360x615 mm)

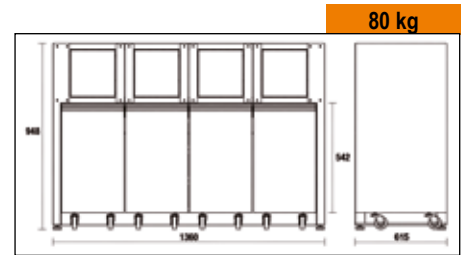

C45PRO 2.0 ML

045002233

Fixed module with built-in sink

- Stainless steel basin
- Supplied complete with:
 - 1 mixer tap
 - 1 drain unit
 - 1 sink stopper
 - 1 filter cap
 - 1 soap dispenser

Fixed two-door module with lock:
 • Usable interior dimensions: 600x603x416 mm
 • With vertically adjustable feet



C45PRO 2.0 ACT

045000247

Fixed module with 3 drawers and 2 built-in reels

- 3 drawers (566x406 mm) with ball bearing slides
- Drawer bases protected by foamed rubber mats
- Front centralized lock
- With vertically adjustable feet

Included

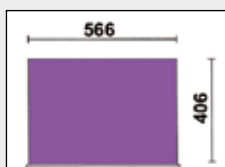

h	max
65 mm	25 kg
145 mm	30 kg

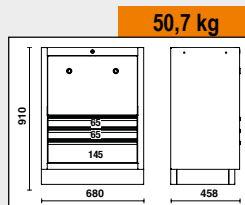

C45PRO 2.0 TC

045000249

Fixed reel module with 3 drawers

- 3 drawers (566x406 mm) with ball bearing slides
- Drawer bases protected by foamed rubber mats
- Front centralized lock
- With vertically adjustable feet

Can accommodate 2 reels, to be chosen from the following (to be ordered separately):

- 2 compressed air or cold water hose reels, 8 mm, length 10 m item 1900S 8x10
- 2 cable reels, to be chosen from the following items: 1843 15-H05, 1844 10-H05, 1844 15-H05, 1844 15-H07, 1845 12-H05, 1846 10-H05, 1846 10-H07 and 1846 15-H05
- 1 compressed air or cold water hose reel, 8 mm, length 10 m item 1900S 8x10 and 1 cable reel, to be chosen from the above-mentioned items

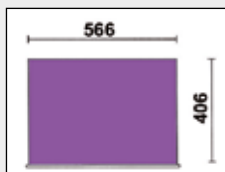

h	max
65 mm	25 kg
145 mm	30 kg

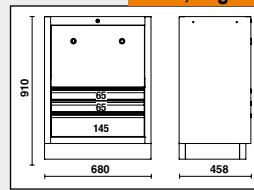

C45PRO 2.0 M4

045000234

Fixed module with 4 drawers

- 4 drawers (566x406 mm) with ball bearing slides
- Drawer bases protected by foamed rubber mats
- Front centralized lock
- With vertically adjustable feet
- Can be fitted with thermoformed trays

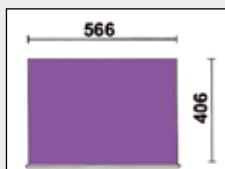

h	max
65 mm	25 kg
145 mm	30 kg
225 mm	30 kg

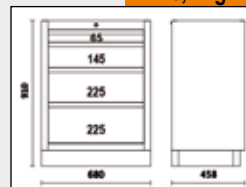

C45PRO 2.0 M5

045000235

Fixed module with 5 drawers

- 5 drawers (566x406 mm) with ball bearing slides
- Drawer bases protected by foamed rubber mats
- Front centralized lock
- With vertically adjustable feet
- Can be fitted with thermoformed trays

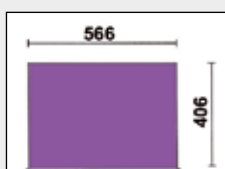

h	max
65 mm	25 kg
145 mm	30 kg

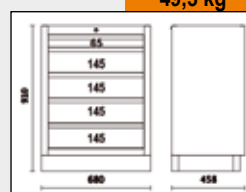

C45PRO 2.0 M7

045000237

Fixed module with 7 drawers

- 7 drawers (566x406 mm) with ball bearing slides
- Drawer bases protected by foamed rubber mats
- Front centralized lock
- With vertically adjustable feet
- Can be fitted with thermoformed trays

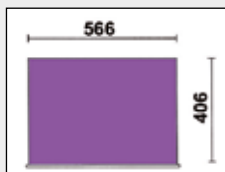

h	max
65 mm	25 kg
145 mm	30 kg

54,3 kg

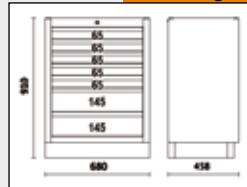

C45PRO 2.0 M8

045000238

Fixed module with 8 drawers

- 8 drawers (566x406 mm) with ball bearing slides
- Drawer bases protected by foamed rubber mats
- Front centralized lock
- With vertically adjustable feet
- Can be fitted with thermoformed trays

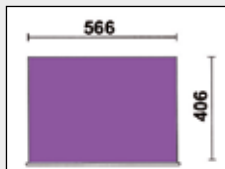

h	max
65 mm	25 kg
145 mm	30 kg

56,8 kg

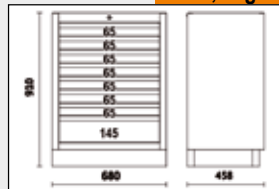

www.beta-tools.com

NEW

ARRANGE YOUR MOBILE ROLLER CAB



ONLINE CONFIGURATOR



C45PRO 2.0 **PM**

045000302

Wall-mounted cabinet

- Cabinet length: 680 mm
- With gas springs, making it easier to open and close door
- With lock

10 kg

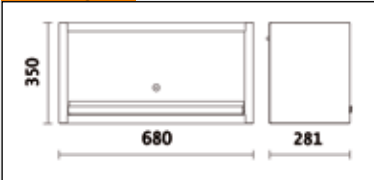

C45PRO 2.0 **PML**

045000303

Wall-mounted cabinet, long version

- Cabinet length: 1360 mm
- With gas springs, making it easier to open and close door
- With lock

17 kg

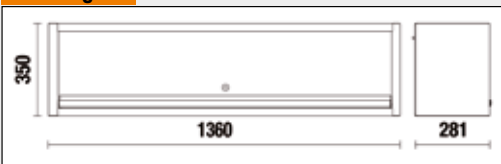

C45PRO 2.0 **PAS**

045000290

Tool wall system

- Aluminium shutter, vertically adjustable, with lock
- Two removable perforated tool panels
- Can be used in combination with 1.3-m-long workbench
- 50-hook GPS kit included

49,7 kg

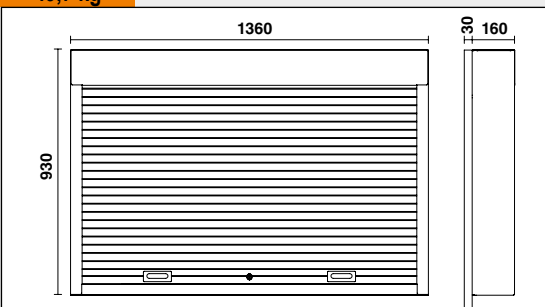

C45PRO 2.0 PF

045000313

Perforated tool panel



1052x614,5x24 mm

5,3 kg

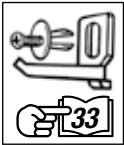

C45PRO 2.0 PFE

045000312

Perforated tool panel

- Can be fitted with 1 power socket (not included)



1052x614,5x24 mm

5,3 kg

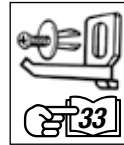

C45PRO 2.0 CPF

045000195

Pair of perforated tool panels for mobile roller cab C45PRO MWS

11 kg

- Supplied complete with framework
- 50-hook GPS kit included

1325x1678x30 mm



526,5 mm

C45PRO 2.0 MP

045000315

Sheet metal shelf for perforated tool panels

614x160x80 mm

2,1 kg



C45PRO 2.0 SS

Side wall brackets

Narrow type

1420x32,5x30 mm

1,5 kg

045000333

C45PRO 2.0 SL

Side wall brackets

Wide type

1420x65x30 mm

2 kg

045000366

C45PRO 2.0 **AS1**

045000451

Sheet metal single-door tool cabinet with bracket

- 4 removable, vertically adjustable shelves
- **Convenient folding clothes rail under first shelf**
- With lock
- Sheet metal door can be installed with right or left opening
- Interior dimensions: 590x430 mm
- With vertically adjustable feet

57,5 kg

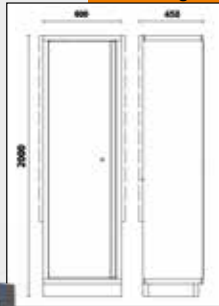

C45PRO 2.0 **AS2**

045000481

Sheet metal two-door tool cabinet with bracket

- 4 removable, vertically adjustable shelves
- With lock
- Interior dimensions: 910x430 mm
- With vertically adjustable feet

80 kg

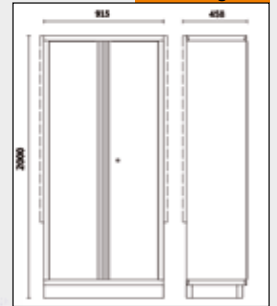

C45PRO 2.0 **A1/R600**

045000466

Interior shelf for tool cabinet C45PRO 2.0 AS1

30 kg



590x430 mm

2,5 kg

C45PRO 2.0 **A1/RB600**

045000467

Interior shelf for tool cabinet C45PRO 2.0 AS1, with clothes rail

30 kg



10 kg

3,3 kg

590x430 mm

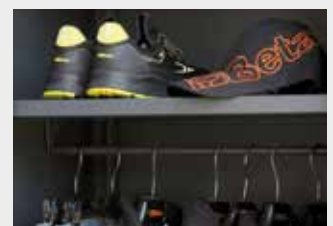

C45PRO 2.0 AS2/3C

045000482

Sheet metal two-door tool cabinet with 3 drawers and bracket

NEW

- 4 removable, vertically adjustable shelves
- Supplied complete with 3-drawer (681x360 mm) module
- Front lock
- Interior dimensions: 910x430 mm
- With vertically adjustable feet

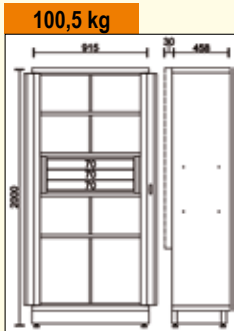

M3CA

088880485

3-drawer module for two-door tool cabinets C45PRO 2.0 AS2

NEW

- 3 fully removable (661x360 mm), with ball bearing slides
- Drawer height: 78 mm
- Drawer bases protected by foamed rubber mats
- Supplied complete with assembly kit

750x400x295 mm

20,5 kg



C45PRO 2.0 A2/R915

045000496

Interior shelf for tool cabinet C45PRO 2.0 AS2

910x430 mm

4,5 kg

50 kg



Reduced space? Do you have a workshop equipment C45PRO and want to tailor it with one of the same size?

Choose one of the C45PRO combination with a **46 CM DEEP WORKTOP**

46cm



C45PRO

C45PRO X

04500001

Combination comprising:

- Stainless steel coated MDF worktop (C45PX/3-2,0MT)
- Fixed module with 7 drawers (C45PRO M7)
- Mobile roller cab with 7 drawers (C45PRO C7)
- Fixed service module (C45PRO MS)
- 3 perforated tool panels (C45PRO PF)
- 3 wall-mounted cabinets (C45PRO PM)
- 3 wall brackets, wide type (C45PRO SL)
- 1 wall bracket, narrow type (C45PRO SS)
- Two-door cabinet (C45PRO AS2)

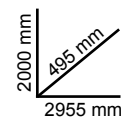

305 kg

C45PRO AX

04500003

Combination comprising:

- Stainless steel coated MDF worktop (C45PX/3-2,0MT)
- Fixed service module (C45PRO MS)
- Fixed module with 7 drawers (C45PRO M7)
- Fixed two-door module (C45PRO MA)
- 3 wall-mounted cabinets (C45PRO PM)
- 3 perforated tool panels (C45PRO PF)
- 2 wall brackets, wide type (C45PRO SL)
- 2 wall brackets, narrow type (C45PRO SS)

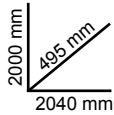

206 kg



C45PRO BX

045000021

Combination comprising:

- Stainless steel coated MDF worktop (C45PX/2-1,3MT)
- Fixed module with 5 drawers (C45PRO M5)
- Fixed two-door module (C45PRO MA)
- 2 wall-mounted cabinets (C45PRO PM)
- 2 perforated tool panels (C45PRO PF)
- 2 wall brackets, wide type (C45PRO SL)
- 1 wall bracket, narrow type (C45PRO SS)
- Single-door cabinet (C45PRO AS1)

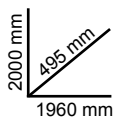

191 kg



Do you already have a C45PRO workshop equipment and **want to buy the new 2.0 version?**

With our **EXTENSION KITS** nothing has ever been so simple.

MODERNITY AND PRACTICALITY IN JUST A FEW STEPS!

C45PRO

Worktop kit

- Thickness: 38 mm
- Can accommodate a vice (1599P/150, to be ordered separately)



- Worktop
- Complete with 6 spacers and 2 exterior side pads

C45PRO 2.0 **PXE**

- Worktop made from **stainless steel coated MDF**

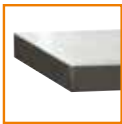

C45PRO 2.0 PXE/1-0,7MT	≡ 680x615x38 mm	2x	045002131
C45PRO 2.0 PXE/2-1,3MT	≡ 1360x615x38 mm	4x	045002133
C45PRO 2.0 PXE/3-2,0MT	≡ 2040x615x38 mm	6x	045002140

NEW

C45PRO 2.0 **PWE**

- Worktop made from **multi-ply wood**



C45PRO 2.0 PWE/1-0,7MT	≡ 680x615x38 mm	2x	045002141
C45PRO 2.0 PWE/2-1,3MT	≡ 1360x615x38 mm	4x	045002143
C45PRO 2.0 PWE/3-2,0MT	≡ 2040x615x38 mm	6x	045002150

NEW

Modular extension low corner kit

- Corner worktop (1018x1018 mm)
- 4 partitions
- 2 lateral fillings

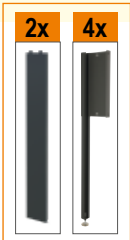

C45PRO 2.0 **CAI/KEPX** 045002500

- **Stainless steel coated MDF** corner worktop

NEW

C45PRO 2.0 **CAI/KEPW** 045002505

- **Multi-ply wood** corner worktop

NEW

Modular extension complete corner kit

- Corner worktop (1018x1018 mm)
- 4 partitions
- 2 lateral fillings
- 2 object holders
- 1 upright

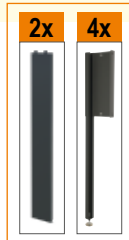

C45PRO 2.0 **CORNER/KEPX** 045002510

- **Stainless steel coated MDF** corner worktop

NEW

C45PRO 2.0 **CORNER/KEPW** 045002515

- **Multi-ply wood** corner worktop

NEW

Assortment of **199** tools in EVA foam trays

19,6 kg

MM11

30



- 42 6-7-8-9-10-11-12-13-14-15-16-17-18- 19-20-21-22-24-27-30-32 mm
- 96BPC/SC9 1,5-2-2,5-3-4-5-6-8-10 mm

MM105

107



1/4" **3/8"** **1/2"**

- 895/1 1/4-1/4
- 895/3 1/4-3/8
- 895/6 5/16-1/2
- 900 4-4,5-5-5,5-6-7-8-9-10-11-12-13-14 mm
- 900L 5-6-7-8-9-10-11-12-13 mm
- 900ME 3-4-5-6-7 mm
- 900LP 0,8x4-1x5,5-1,2x6,5-1,2x8
- 900PH PH1-PH2-PH3-PH4
- 900TX T10-T15-T20-T25-T27-T30-T40
- 900/16
- 900/... 50-100-150 mm
- 900/25
- 900BG/30 176 mm
- 900/42 115 mm
- 900/55 125 mm
- 910A 6-7-8-9-10-11-12-13-14-15-16-17-18-19-20-21-22 mm
- 910/15 3/8-1/4
- 910/16 3/8-1/2
- 910/21 125 mm
- 910/22 250 mm
- 910/25
- 910/42 210 mm
- 910/55 200 mm
- 920A 8-10-11-12-13-14-15-16-17-18-19-20-21-22-23-24-26-27-28-30-32 mm
- 920/15 1/2-3/8
- 920/25
- 920AN 125-250 mm
- 920/42 305 mm
- 920/55 275 mm
- 956E 16 mm (5/8")-17,8 (11/16")-20,8 (13/16")

MM129

12



- 1032 180 mm
- 1034 170 mm
- 1036 175 mm
- 1038 175 mm
- 1048N 250 mm
- 1052 240 mm
- 1082BM 160 mm
- 1098 220 mm
- 1128BMX
- 1150BM 180 mm
- 1166BM 160 mm
- 1168BM 160 mm

MM210

25



- 1201E 2,5x50-3x75-4x100-5,5x125-6,5x150-8x200 mm
- 1201EN 4x30 mm
- 1202E PH0x60-PH1x80-PH2x100-PH3x150 mm
- 1201EN PH1X30 mm
- 1207E/TX T6-T7-T8-T9-T10-T15-T20-T25-T27-T30-T40-T45
- 1253 3,5x100 mm

MM230

25



- 30 \varnothing 2-3-4 mm
- 31 \varnothing 2-3-4-5-6-8 mm
- 32 \varnothing 4 mm
- 34 150 mm
- 35 200-250 mm
- 36 125 mm
- 1370 500 g
- 1390 \varnothing 35 mm
- 1692 3 m
- 1712TF
- 1719BMA...Q 200 mm
- 1719BMA...T 200 mm
- 1719BMA...P 200 mm
- 1719BMA...M 200 mm
- 1719BMA...R 200 mm
- 1737NX
- 1771

Assortment of **85** tools for universal maintenance fixing accessories included

11,3 kg

Quantity/Description	Beta N.
17 Combination wrenches 6÷22 mm	42
12 Offset hexagon key wrenches \varnothing 2÷10 mm	96N/SC12
13 1/2" square drive hexagon sockets with rail \varnothing 10÷22 mm	920A/SB13
8 1/2" square drive hexagon sockets with rail \varnothing 23÷32 mm	920A/SB8
1 1/2" drive extension bar 125 mm	920/21
1 1/2" drive extension bar 255 mm	920/22
1 1/2" drive universal joint	920/25
1 1/2" drive sliding T-handle	920/42
1 1/2" drive reversible ratchet \otimes	920/55
1 Circlip pliers straight, internal \varnothing 180 mm	1032
1 Circlip pliers straight, external \bullet 175 mm	1036
1 Slip joint pliers boxed joints 250 mm	1048N
1 Self - locking pliers 240 mm	1052
1 Heavy-duty diagonal cutting nippers \sphericalangle 160 mm	1084BM

Quantity/Description	Beta N.
1 Electrician's scissors, straight blades	1128BMX
1 Combination Pliers \equiv 180 mm	1150BM
1 Extra-long needle nose pliers \bullet 160 mm	1166BM
7 Screwdrivers for slotted head screws \bullet 3x75 - 3,5x100 - 4x125 5,5x150 - 6,5x150 - 8x200 - 10x200 mm	1260
4 Screwdrivers for cross head Phillips® screws \oplus PH0x60 - PH1x80 - PH2x100 - PH3x150 mm	1262/S4
1 Engineer's hammer 300 g	1370
1 Soft face hammer \varnothing 35 mm	1390
1 Measuring tape 5 m	1692
5 Set of 5 second-cut files, with handles 200 mm	1719BMA/S5
1 Hacksaw frame, aluminium handle	1725
1 Plastic oil can 150 cc	1754
1 Snap - off blade utility knife	1771

		5000 RSC50 2.0/PLED-ST	5000 RSC50 2.0/PLEDC	5000 RSC50 2.0/ASL	5000 RSC50 2.0/CTR
					
	A	1x	-	1x	-
	B	-	1x	1x	1x
	A	1x	1x	1x	-
	B	-	2x	1x	1x
	A	1x	2x	1x	-
	B	-	3x	1x	1x

5000 RSC50 2.0/PLEDC

050001712

Aluminium profile with LED strip

- 6.5W IP20 LED strip; length: 50 cm
- Supplied complete with cables
- Convenient fixing through magnets

80 g



5000 RSC50 2.0/PLED-ST

050001715

Aluminium profile with LED strip and SOFT TOUCH switch

- 6.5W IP20 LED strip; length: 50 cm
- Supplied complete with cables
- Convenient fixing through magnets

80 g

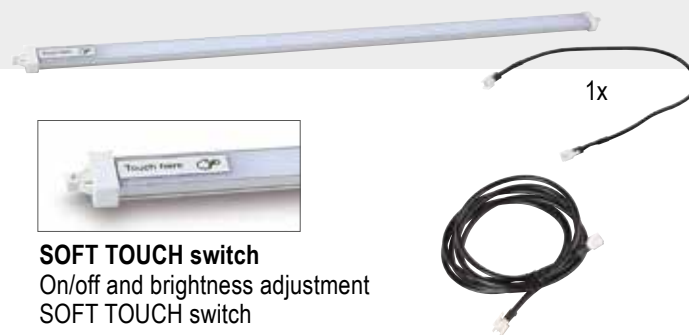

5000 RSC50 2.0/CTR

050001721

LED strip controller, with RF remote control

For use only with LED strip item 5000 RSC50 2.0/PLEDC

Kit contents:

- 1 mini receiver
- 1 wireless RF remote control

25 g



Specifications of mini receiver:

- Input voltage: 5V -24VDC
- Rated output current: 5A
- Peak output current: 12A
- Operating temperature: -20 °C ÷ +35 °C

Specifications of RF remote control:

- ON/OFF button
- BRIGHT +/- button: allows manual brightness adjustment
- 25% / 50% / 100% button: allows automatic brightness adjustment
- Battery: 3V CR2025 (included)
- Dimensions: 86 (L) x 40 (W) x 7 (H) mm

Integrated features:

- Memory
- Mode (manual/automatic brightness)
- Brightness adjustment

86x40x7 mm

5000 RSC50 2.0/ASL

050001716

Power supplier for LED strip

- 24VDC 22W power supplier
- Can supply power to max. 3 6.5W LED strips

210 g



C45 STR

Coloured adhesive tape

- Allows tailoring of colour of horizontal and vertical inserts in workshop equipment combination C45PRO 2.0

RAL2011
RAL9006
RAL3000
RAL5015
RAL1023
RAL6029



C45STR-O/2011	30 m		045000911
C45STR-G/9006	25 m		045000912
C45STR-R/3000	25 m		045000913
C45STR-B/5015	25 m		045000914
C45STR-Y/1023	25 m		045000915
C45STR-V/6029	25 m		045000916

SPC

088880480

Computer wall bracket

- Matches tool wall systems C45PRO 2.0



398x243x138 mm

1,5 kg

SP5S

088880475

Wall-mounted support with 5 compartments

- Made from sheet metal
- 5 tool compartments varying in height



260x60x290 mm

1 kg

SSPE

088880482

Under-cabinet support for power tools

- For use only under suspended cabinet C45PRO 2.0 PM (workshop equipment C45PRO 2.0)
- With 5 convenient slots for accommodating power tools



680x280x150 mm

6 kg



CP

088880470

Wall-mounted bottle rack, made from steel

- Can be used with wall-mounted tool panels
- Supplied complete with 2 supports

533 g

280x95x115 mm



PM/5C

088880450

Wall-mounted small parts holder with 5 tote trays, made from plastic, with support

- Interior drawer dimensions 95x120 mm
- Can be used with tool wall systems: C45PRO 2.0

2,7 kg

600x140x165 mm



PM/6C

088880440

Wall-mounted small parts holder with 6 tote trays, made from plastic, with support

- Interior drawer dimensions 80x60 mm
- Can be used with tool wall systems: C45PRO 2.0

970 g

600x95x115 mm



CPMB/3C

088880443

Workbench small parts containers with 3 drawers

- Interior drawer dimensions: 160x107x105h mm

2,3 kg

600x155x175 mm



CPMB/5C

088880445

Workbench small parts containers with 5 drawers

- Interior drawer dimensions: 90x86x62h mm

1,7 kg

600x133x132 mm



KIT 6VC/3C

088880453

Kit of 6 removable trays for small parts containers CPMB/3C

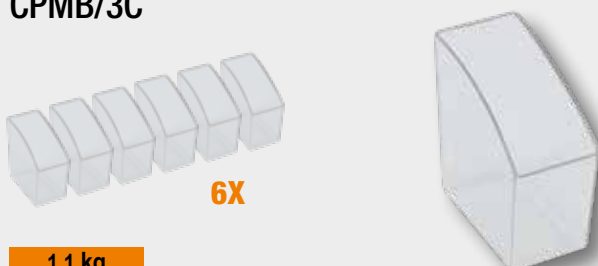

6X

1,1 kg

KIT 10VC/5C

088880455

Kit of 10 removable trays for small parts containers CPMB/5C

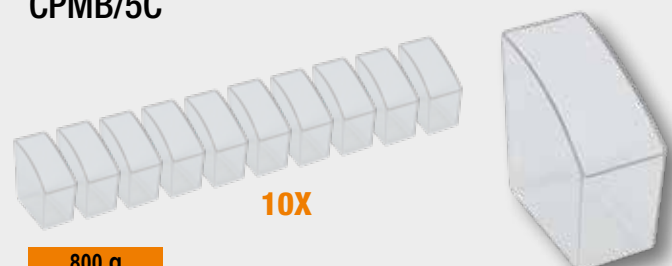

10X

800 g

SB

Socket rails



SB1	L 210 mm	088880201
SB2	L 280 mm	088880202
SB3	L 360 mm	088880203

MB

Socket clips for rails SB



ME0	<input type="checkbox"/> 1/4	088880210
ME1	<input type="checkbox"/> 3/8	088880211
ME2	<input type="checkbox"/> 1/2	088880212

KIT/GPS

Kit of GPS hooks with VE1 screws

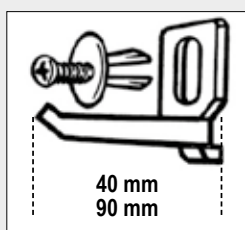

KIT/GPS	L 40 mm	50 pc	088880119
KIT/GPS	L 90 mm	50 pc	088880117

GM

Snap hooks with VE1 screw

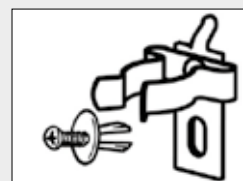

GM6,5	Ø 6,5 mm	088880250
GM9,5	Ø 9,5 mm	088880251
GM13	Ø 13 mm	088880252
GM16	Ø 16 mm	088880253
GM19	Ø 19 mm	088880254
GM25	Ø 25 mm	088880255

8889**PS/7**

088890407

Parallel partitions
for item C45PRO 2.0
M4/M5/M7/M8/M3A/ACT/TC

1,3 kg

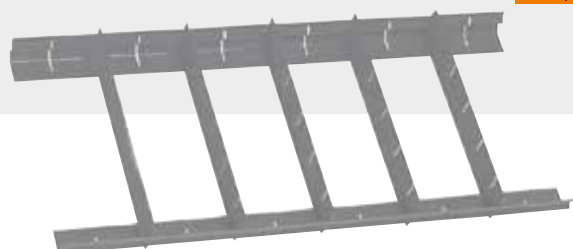

8889**CS/7**

088890417

Crossed partitions
for item C45PRO 2.0
M4/M5/M7/M8/M3A/ACT/TC

1,9 kg

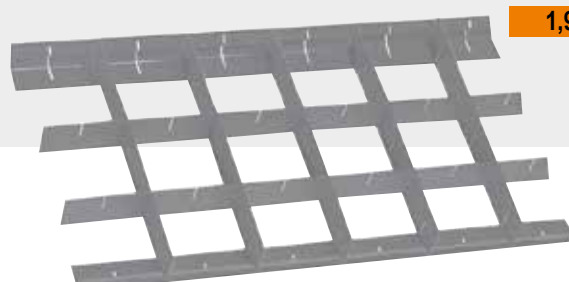

S55/8

Supports for 8 double open end wrenches, made from sheet metal

≡ 173x113x36 mm

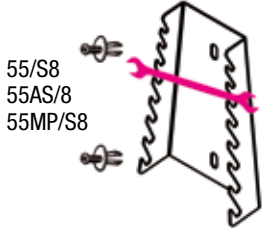

55/S8
55AS/8
55MP/S8

088880420

S55/12

Supports for 12 double open end wrenches, made from sheet metal

≡ 286x138x44 mm

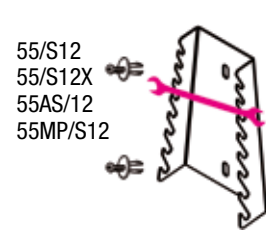

55/S12
55/S12X
55AS/12
55MP/S12

088880421

ST2P

Pliers pockets, made from sheet metal

≡ 116x60x31 mm

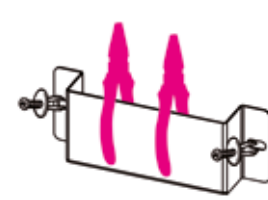

088880422

TSP

Tool pockets, made from plastic material

≡ 167x55x16 mm

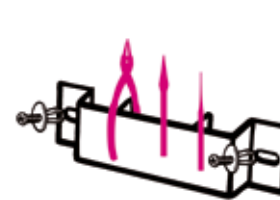

088880402

S952/10

Supports for 10 T-handles, made from sheet metal

≡ 385x97x26 mm

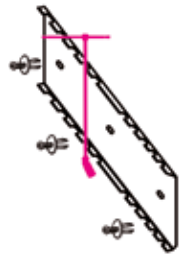

088880423

S1719BM

Supports for 5 files, made from sheet metal

≡ 165x48x32 mm

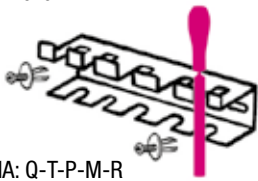

1719BMA: Q-T-P-M-R
1719BMD: Q-T-P-M-R
1719BMX: Q-T-P-M-R

088880404

SGN

Supports for 2 mini screwdrivers, made from sheet metal

≡ 60x23x26 mm

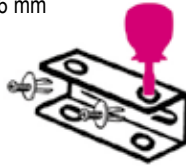

1290N-1292N-1299N/PZ
1260N-1262N-1269N/PZ
1201EN-1202EN-1209EN/PZ

088880405

S42/17

Supports for 17 combination wrenches, made from sheet metal

≡ 577x42 mm

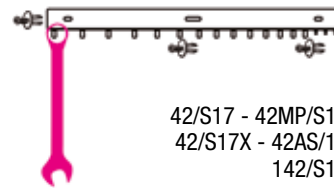

42/S17 - 42MP/S17
42/S17X - 42AS/17
142/S17

088880428

S951/6

Supports for 6 T handle wrenches with hexagon male ends, made from sheet metal

≡ 161x50x43 mm

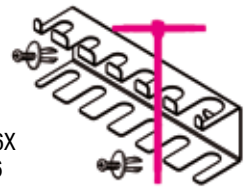

951/S6
951AS/S6X
951TX/S6

088880429

SPG11

Supports for screwdrivers, made from sheet metal

≡ 283x49x35 mm

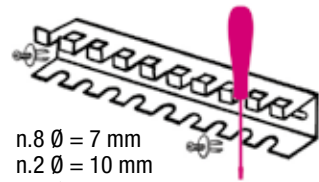

n.8 Ø = 7 mm
n.2 Ø = 10 mm
n.1 Ø = 12 mm

088880910

S1203/8

Supports for screwdrivers, made from sheet metal

≡ 283x49x35 mm

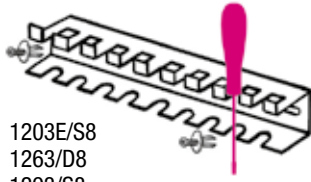

1203E/S8
1263/D8
1293/S8

088880430

S96T/8

Supports for 8 offset hexagon key wrenches, with high torque handles, made from sheet metal

≡ 282x49x45 mm

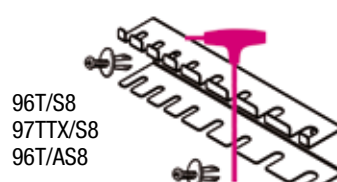

96T/S8
97TTX/S8
96T/AS8

088880431

96T/SPV

Supports for 11 offset hexagon key wrenches, with high torque handles, made from sheet metal

≡ 282x49x50 mm

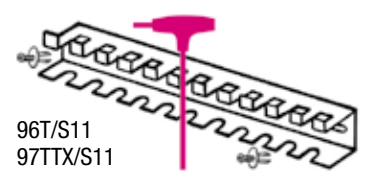

96T/S11
97TTX/S11

000960958

3D PLANNER

Imagine and create...

Configure your workshop in 3D online



1 Draw the walls

Create the walls according to the dimensions of your workshop.

2 Design your workbench system

Select and assemble the component parts, to make your own combination.

3 View the result in 3D

The combination is immediately displayed in 3D and can be viewed from different angles.

4 Request a quote





Print the detail of the arrangement in PDF format and take it to your dealer to get a quote.

CUSTOMIZED MODULES ON REQUEST

Fill your drawers with customized modules in six steps

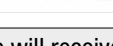

1 Determine your needs and send your project to the Beta dealer

2	Image	Product	Cod. Beta
		Self-locking pliers	010540022
		Pliers	010440250
		Pliers	011500046
		Screwdrivers for slotted head screws	012011039
		Screwdrivers for cross head Phillips® screws	012021018

2 We will receive and codify your initial assortment of the project



3 We will execute the design

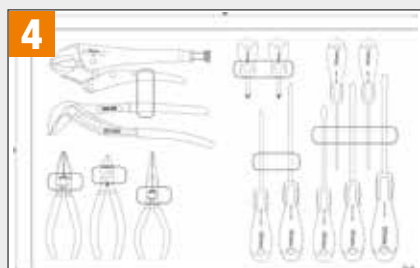

4 We will submit the final layout for your approval



5 We will build the soft modules in Beta's factory in Sovico



6 We will deliver the tools in the customized modules



2024 MOT02
WORLD CHAMPIONSHIP

ALONSO LÓPEZ

FERMÍN ALDEGUER

099804939

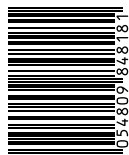

8 054809 848181

Beta Utensili S.p.A. | via Volta, 18 | 20845 Sovico (MB)
tel +39 039 20771

www.beta-tools.com